



VOLKSWAGEN ID. BUZZ 2022+

KU-Z SIDESTEP

INSTALLATION GUIDE



60 min.

131-235 KIT KU-Z (ID.BUZZ SIDESTEP)

L1 length is 2220 mm
L2 length is 2470 mm

FRONT

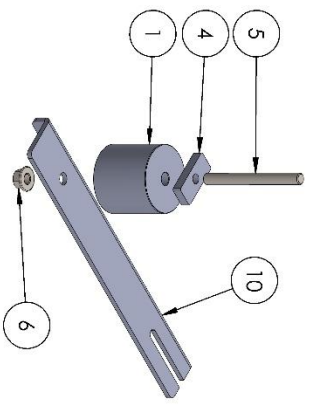
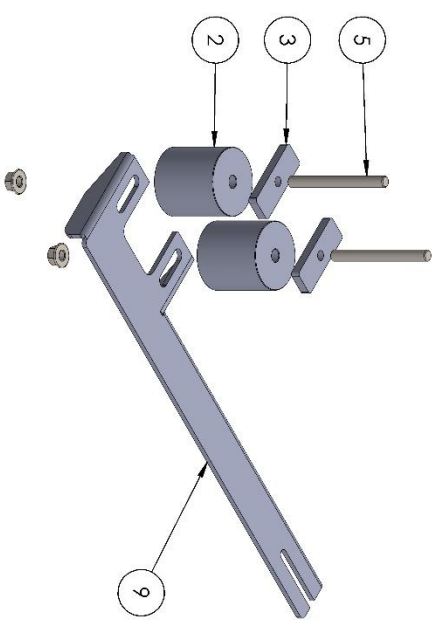



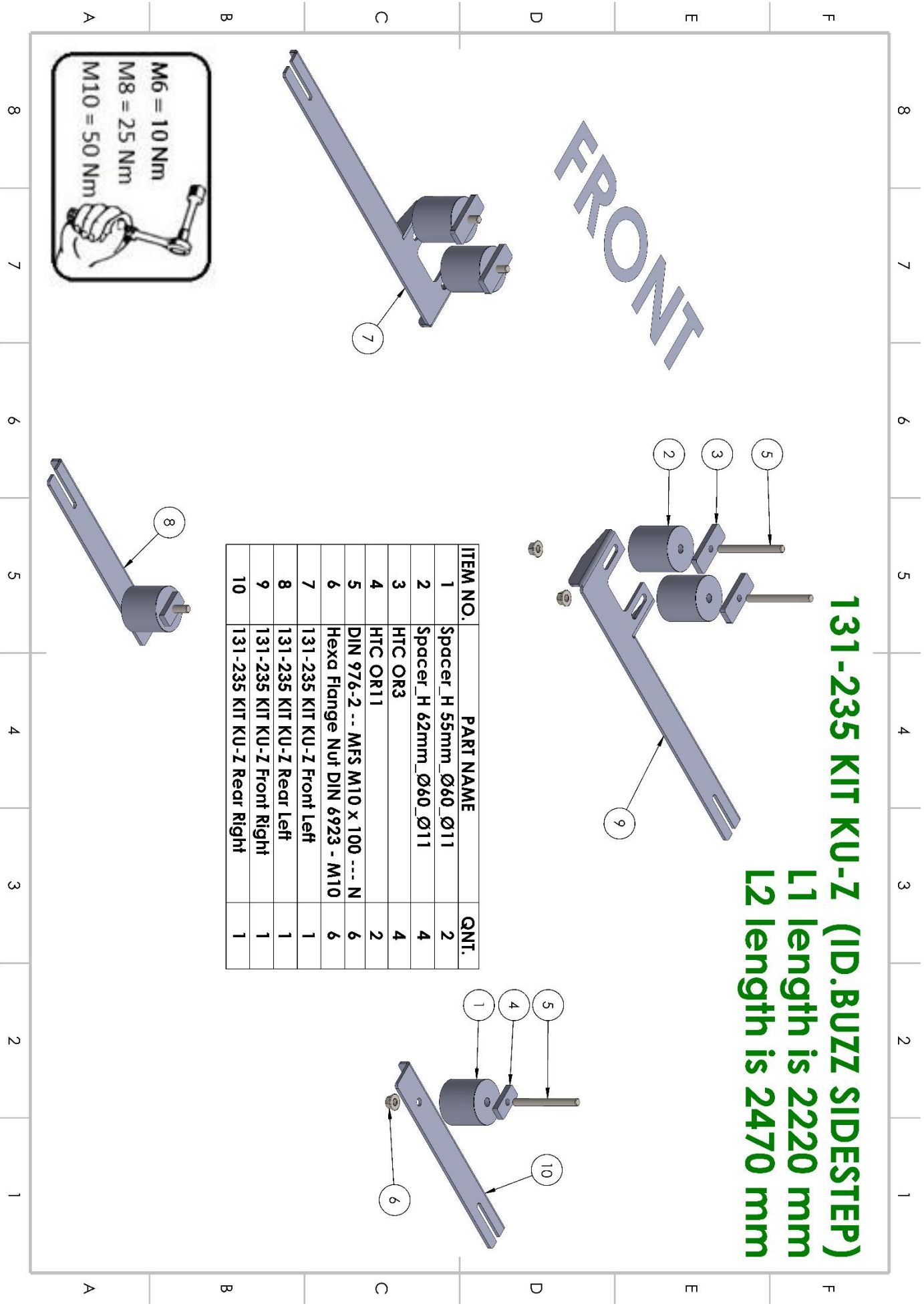
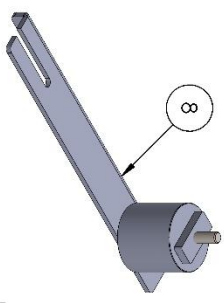

ITEM NO.	PART NAME	QNT.
1	Spacer_H 55mm Ø60 Ø11	2
2	Spacer_H 62mm Ø60 Ø11	4
3	HTC OR3	4
4	HTC OR11	2
5	DIN 976-2 -- MFS M10 x 100 ---- N	6
6	Hexa Flange Nut DIN 6923 - M10	6
7	131-235 KIT KU-Z Front Left	1
8	131-235 KIT KU-Z Rear Left	1
9	131-235 KIT KU-Z Front Right	1
10	131-235 KIT KU-Z Rear Right	1

M6 = 10 Nm
M8 = 25 Nm
M10 = 50 Nm

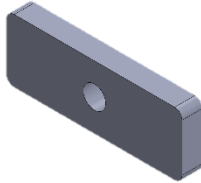
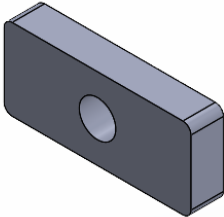

Box Contents

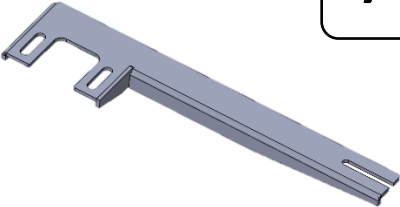
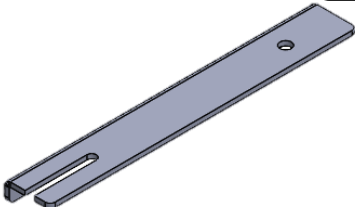
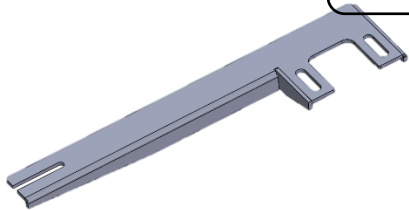
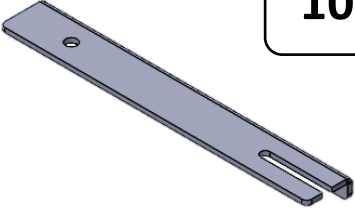
 <p>1</p> <p>Spacer_H 55mm_Ø60_Ø11</p>	 <p>2</p> <p>Spacer_H 62mm_Ø60_Ø11</p>	 <p>3</p> <p>HTC OR3</p>
 <p>4</p> <p>HTC OR11</p>	 <p>5</p> <p>STUD BOLT M10 x 100</p>	 <p>6</p> <p>Hexa Flange Nut DIN 6923 - M10</p>
 <p>7</p> <p>131-235 KIT KU-Z Front Left</p>	 <p>8</p> <p>131-235 KIT KU-Z Rear Left</p>	 <p>9</p> <p>131-235 KIT KU-Z Front Right</p>
 <p>10</p> <p>131-235 KIT KU-Z Rear Right</p>		

Brackets Assembly

1



Search for covers Left + Right.

2



Remove screws and open cover.

3

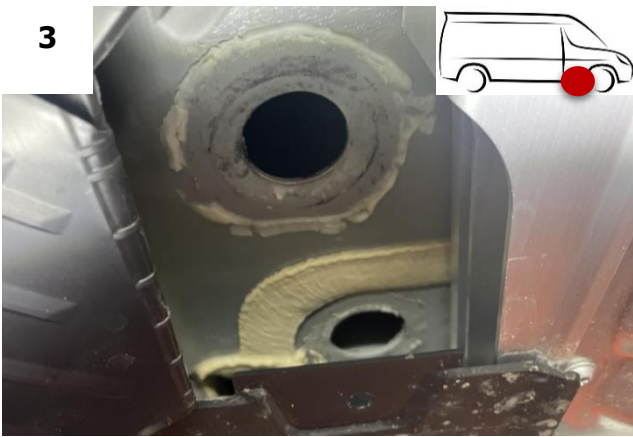

Find original holes in body of your ID.BUZZ

4



Place M10 plate 2 on every side of the vehicle. HTC OR3

5

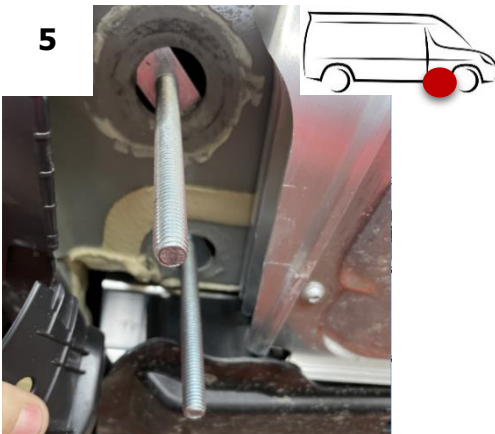

Insert M10x100 inside the plates.

6

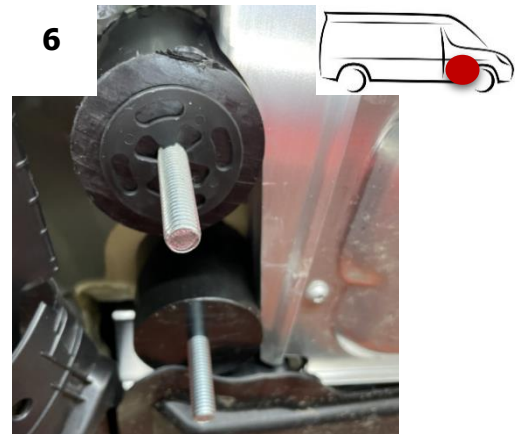

Place spacer 70 mm high.



7

Place Front bracket and tighten by hand with M10 nuts.

Foto is Left side of the Vehicle.

Place Right bracket in Mirror position.



8

Remove cover Left + Right.

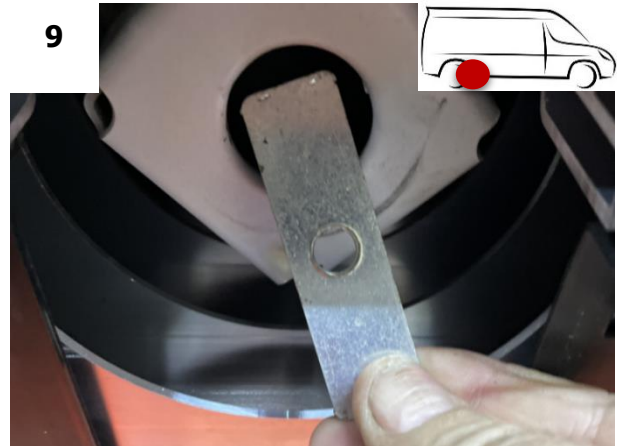

9

Place M10 plate (small) inside. HTC OR4

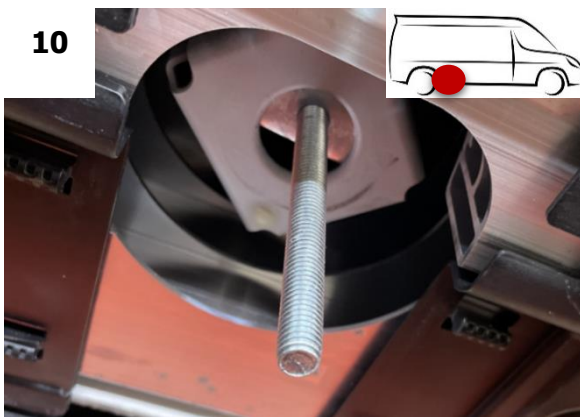

10

Insert M10x100 inside the plates.

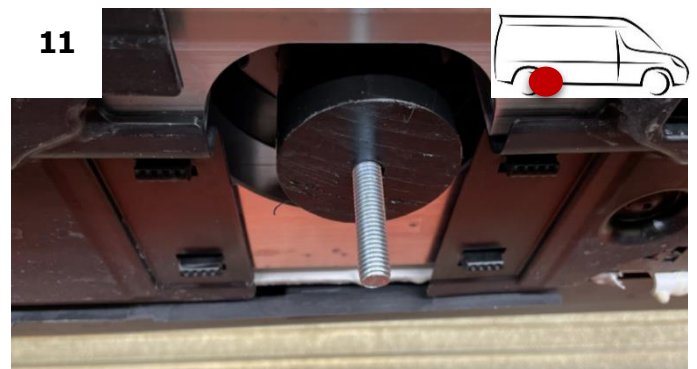

11

Place spacer 42 mm.



12

FINNALLY: Place sidebar to the brackets

(bolts) and tighten them with nuts and rivets.

Tighten everything with correct moment and replace bottom cover.

Place Rear Bracket on the M10 treadend and tighten (by hand) with M10 nut.